

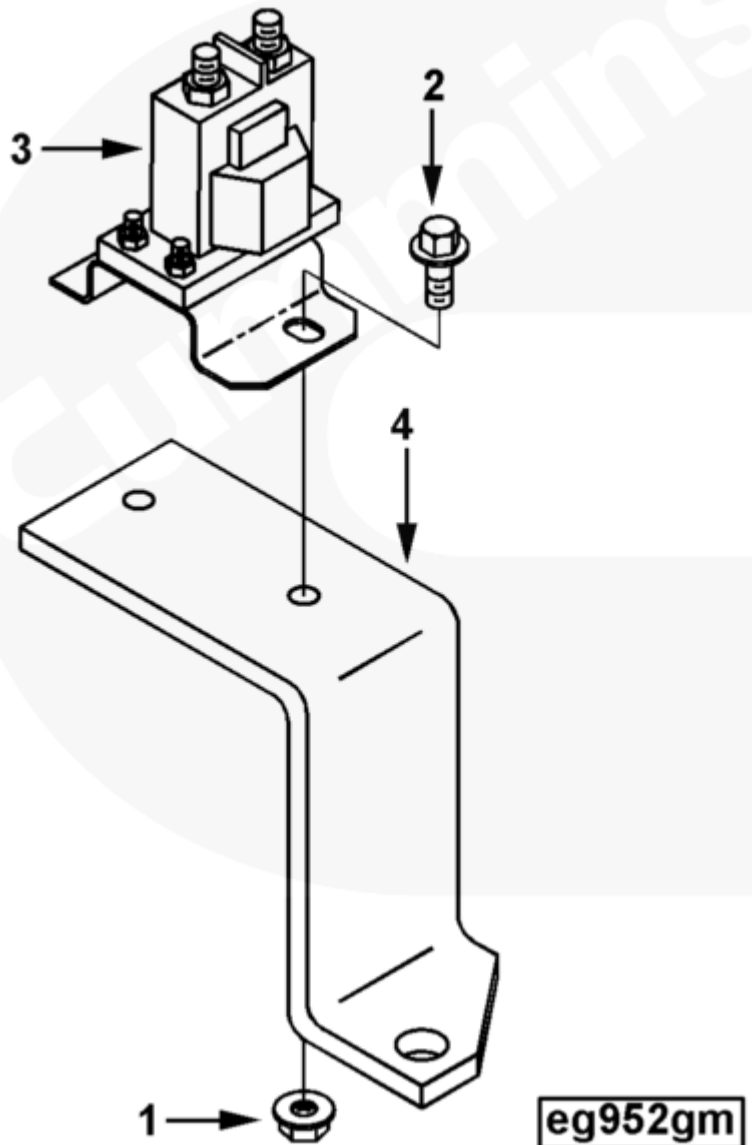

Parts Catalog - Option Detail

Electronic Parts Catalog - Option Detail				
Option	Group	Graphic	Film Card	Date
EG9198	15.08	eg952gm	Z	15-OCT-98
Engines	6C8.3, C GAS PLUS CM556, G8.3, G8.3 CM558, GTA8.3 CM558, ISC CM2150, ISC CM554, ISC CM850, ISC8.3 CM2250, ISC8.3 G CM2180 C101, ISL CM2150, ISL CM554, ISL CM850, ISL G CM2180, ISL8.9 CM2150 L110, ISL8.9 CM2880 L112, ISL9 CM2150 SN, ISL9 CM2250, ISL9 CM2350 L101, ISL9 CM2350 L111, ISLE4 CM850, L GAS PLUS CM556, L8.9, L8.9 L121, L8.9G CMOH2.0 L125B, L9 CM2350 L116B, L9 CM2350 L119B, L9 CM2350 L120C, L9 CM2350 L123B, L9.3 L105, L9.5 L117, L9N CM2380 L124B, QSC8.3 CM2250, QSC8.3 CM2880 C102, QSC8.3 CM554, QSC8.3 CM850(CM2850), QSL9 CM2250, QSL9 CM2250 L115, QSL9 CM2350 L102, QSL9 CM2350 L107, QSL9 CM2350 L118, QSL9 CM2350 L122, QSL9 CM554, QSL9 CM850(CM2850), QSL9 G CM558, QSL9 M CM2250 L106, QSL9.3 CM2880 L113			



SMALL | MEDIUM | LARGE

Cart	Ref No	Part Number	Part Description	Required	Remarks
View My Cart					
		EG9198	Electric Starting Accessories		
					12volt magnetic switch
					mounted on engine for
					negative ground electrical
					systems.
<input type="checkbox"/>	1	3906216	Hexagon Flange Nut	2	M6 X 1.00.
<input type="checkbox"/>	2	3913638	Hexagon Flange Head Cap Screw	2	M6 X 1.00 X 16.
<input type="checkbox"/>	3	3916301	Magnetic Switch	1	
<input type="checkbox"/>	4	4003740	Magnetic Switch Bracket	1	

© 2019 Cummins Inc., Box 3005, Columbus, IN 47202-3005 U.S.A.
Terms of Use and Disclaimers | Recommended System Requirements
Need Assistance? Please click on the Contact Us button in the top right corner of any page.